

DENSO

Barcode/2D code
Handy Terminal

BHT-M70

Hardware User's Manual



Preface

Thank you for using the DENSO WAVE Barcode Handy Terminals BHT-M70.

Please read this manual thoroughly prior to the operation to ensure full use of the product's functionality, and store safely in a convenient location for quick reference even after reading.

This is an instruction manual for the BHT-M70.

The BHT-M70 is developed as wireless stations for the low power data communication system and has been given a certificate of technological conformance defined by the applicable radio law, allowing users not to apply for or obtain a license to use a wireless station. Any modification or reconstruction of the radio station is strictly banned by the radio law and anyone who has violated this regulation is subject to penalties.

Bluetooth® is a registered trademark of Bluetooth SIG and DENSO WAVE is using it under its license.

The firmware of this product shall not be reverse-engineered, decompiled, disassembled, integrated, modified or transformed in anyway or any form.

LCD may contain not illuminated pixels or always illuminated pixels. It may also contain uneven color and brightness. They are not failures. Slight Newton's ring may happen to appear on the touch screen, but it is not a failure, either.

Liability Limitations

- DENSO WAVE INCORPORATED does not assume any product liability (including damages for lost profits, interruption of operations, or the loss of business-related information) arising out of, or in connection with, the use of, or inability to use the BHT system software or related manuals.
- DENSO WAVE INCORPORATED ("DENSO WAVE") takes reasonable precautions to ensure its products do not infringe upon any patents or other intellectual property rights of other(s), however, DENSO WAVE cannot be responsible for any patent or other intellectual property right infringement(s) or violation(s) arising from any of the following 1) - 3).
 - 1) The use of DENSO WAVE's products in connection or in combination with other components, products, devices, data processing systems or software not supplied by DENSO WAVE.
 - 2) The use of DENSO WAVE's products in a manner for which they were not intended nor designed.
 - 3) The modification of DENSO WAVE's products by parties other than DENSO WAVE.
- If it is judged by DENSO WAVE INCORPORATED that malfunction of the product is due to the product having been dropped or subjected to impact, repairs will be made at a reasonable charge even within the warranty period.
- DENSO WAVE will not bear any responsibility for data which customers have recorded and are received by DENSO WAVE for repair and analysis.

Customer Registration and Inquiries

Customer Registration

To allow us to provide our customers with comprehensive service and support, we request that all customers complete a Member Registration Form. Registered members will be offered the following privileges.

- The latest upgrade information
- Free exhibition and event information for new products
- Free Web-information service "QBdirect"

QBdirect Service Contents

Information search service (FAQ)	Offers detailed information on each product.
Download service	Offers downloads of repair modules for the latest BHT Series systems or software, and sample programs.
E-mail inquiries	Product related queries can be sent in by e-mail.

Please note that these privileges may be subject to change without prior notice.

How to Register

Access the URL below and follow the instructions provided.

<http://www.qbdirect.net>

Inquiries

For inquires relating to products, please access our website <https://www.denso-wave.com> .
Technical inquiries can be made at our exclusive website for registered users (QBdirect).

Safety Precautions

Be sure to observe all these safety precautions.



Please **READ** through this manual carefully. It will enable you to use the BHT and CU correctly.
Always keep this manual nearby for speedy reference.

Safety precautions description in this document



Strict observance of these warnings and cautions is a **MUST** for preventing accidents that could result in bodily injury and substantial property damage. Make sure you fully understand all definitions of these terms and symbols given below before you proceed to the text itself.

Warning levels and meaning of symbols are as follows;

Warning level

 DANGER	Alerts you to those conditions that could imminently lead to serious bodily injury or death if the instructions are not followed correctly.
 WARNING	Alerts you to those conditions that could cause serious bodily injury or death if the instructions are not followed correctly.
 CAUTION	Alerts you to those conditions that could cause minor bodily injury or substantial property damage if the instructions are not followed correctly.

Meaning of symbols

	A triangle (▲) with a picture inside alerts you to a warning of danger. Here you see the warning for electrical shock.
	A diagonal line through a circle (⊘) warns you of something you should not do; it may or may not have a picture inside. Here you see a screwdriver inside the circle, meaning that you should not disassemble.
	A blue circle (●) with a picture inside alerts you to something you MUST do. This example shows that you MUST unplug the power cord.



Handling the batteries

Wrong handling the batteries may result in electrical shock, overheating, smoke generation, combustion, blowout, or leakage of battery fluid. Please read the following items prior to use.

A red circle with a diagonal slash over a battery icon.	<ul style="list-style-type: none">• Never disassemble or modify the battery.
A red circle with a diagonal slash over a hammer icon.	<ul style="list-style-type: none">• Do not stick a needle into the battery, hammer at it, or tread on it.• Avoid dropping or throwing the battery or letting it undergo any shock or impact.• Do not use significantly damaged or deformed batteries. Do not use batteries when they are subject to the impact, for example, a drop impact.• Never connect the battery (+) and (-) terminals with a metal object such as a piece of wire.• Do not carry or store the battery together with metallic ball-point pens, necklaces, coins, hairpins, etc.• Do not get the BHT wet or put it in water or seawater.
A red circle with a diagonal slash over a lit match icon.	<ul style="list-style-type: none">• Never burn or heat the battery.• Never use, leave, or charge the battery in the vicinity of high-temperature locations (60 °C or higher) such as a fire, stove, or under a scorching sun.• Do not use or store the battery in places exceeding the service or storage temperature.
A red circle with a diagonal slash over a fire icon.	<ul style="list-style-type: none">• Never charge the battery near a fire or in strong sunlight. Raised battery temperature may result in leakage of battery fluid, blowout, or combustion.• Never charge or use the battery where any inflammable gases may be emitted.• Never apply solder directly to the battery.• Do not use batteries other than the specified ones.
A blue circle with a white exclamation mark.	<ul style="list-style-type: none">• If the battery fluid leaked from the battery gets into the eyes, wash thoroughly with clean water such as tap water without rubbing and obtain medical treatment immediately. Failure to do so will result in eye injuries.• During use, charging, or storage of the battery, if odors come from the battery, the battery is overheated, discolored, deformed, or anything unusual is found, unload the battery from the BHT or charger. Do not use the battery.
A blue circle with a white battery icon and a charging symbol.	<ul style="list-style-type: none">• If the battery does not finish recharging within the specified time, stop recharging.









WARNING

To system designers

	<ul style="list-style-type: none"> When introducing BHTs in those systems that could affect human lives, develop applications carefully through redundancy and safety design which avoids the feasibility of affecting human lives even if a data error occurs.
---	--

Handling the BHT



Wrong handling of the BHT may affect normal operation or result in, electric shock, generating heat and smoke, and vision disturbance. Be sure to observe the following.

	<ul style="list-style-type: none"> Never disassemble or modify the BHT.
	<ul style="list-style-type: none"> Avoid dropping or throwing the battery or letting it undergo any shock or impact. When the BHT is subject to the strong impact, for example, a drop impact, check the case for any damage and the battery for damage, leakage and overheating. Never use a battery once it is damaged, heated or has a fluid leakage. Never use a damaged case. Never use damaged or leaked batteries. If the battery fluid leaked from the battery gets into the eyes, wash thoroughly with clean water such as tap water without rubbing and obtain medical treatment immediately. Failure to do so will result in eye injuries. Do not insert any foreign materials into the battery cartridge. Do not get the BHT wet or put it in water or seawater. Never put the BHT in a microwave oven or high-pressure container. Never put the BHT in places where there are excessively high temperatures, such as inside closed-up automobiles, or in places exposed to direct sunlight. Avoid using the BHT in extremely humid or dusty areas, or where there are drastic temperature changes.
	<ul style="list-style-type: none"> If smoke, abnormal odor or noise comes from the BHT, immediately turn off the power and remove the battery cartridge from the scanner case.
	<ul style="list-style-type: none"> If the LCD screen is broken by mistake, care must be taken not to get the liquid crystal into your eyes or mouth or drop it on your skin.
	<ul style="list-style-type: none"> Be careful of broken glass if the LCD screen is accidentally cracked or broken. It may cause bodily injury.
	<ul style="list-style-type: none"> If the LCD screen is accidentally broken and liquid crystal gets into your eyes or mouth, wash it off immediately with clean water and then seek medical care. Or, if it is attached to your skin or clothes, wipe it off immediately and then wash it using soap and water. Failure to do so may lead to vision loss or cause trouble in the skin. Never stare into the reading window. Failure to do so will result in vision disturbance.

BHT-M70 Series

Handling the batteries

Wrong handling the batteries may result in electrical shock, overheating, smoke generation, combustion, or blowout. Please read the following items prior to use.

	<ul style="list-style-type: none">• The battery is exclusively for the BHT. Do not use the battery for purposes other than charging the BHT.
	<ul style="list-style-type: none">• Use the specified charger or charging cable.• If abnormal odor, heat, discoloration, deformation or any other abnormal conditions are noticed when the battery is in use, being charged, or is in storage, remove it from the BHT or charger and avoid further use.

Handling the scanner using a laser light

	<ul style="list-style-type: none">• Never stare into the laser light.• Never point the code reading windows at someone's eyes.
---	---

- The 2D Code Handy Terminal uses a laser light for indicating the scanning range. The intensity of the laser light is too low to inflict bodily injury. However, do not stare into beam. You must observe the following precautions when handling the BHT equipped with laser light.
 - 1) Never stare into the reading window.
 - 2) Never point the reading window at someone's eye.
- Complies with 21 CFR 1040.10 and 1040.11 except for conformance with IEC 60825-1 Ed. 3., as described in Laser Notice No. 56, dated May 8, 2019.

[BHT-M70 series]

Barcode reading window

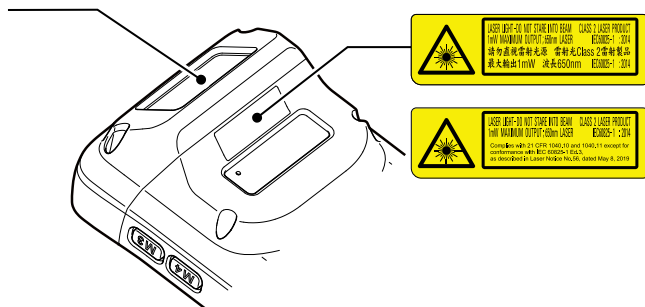

- LASER LIGHT-DO NOT STARE INTO BEAM.CLASS 2 LASER PRODUCT.
- LUMIERE LASER- NE PAS REGARDER DANS LE FAISCEAU. APPAREIL A LASER DE CLASS 2

Secured Three-year Warranty

If you register the serial number of the product within one month after your purchase, the warranty of the registered product will be prolonged to three years from the one-year warranty.

Please access the URL below to register.
<https://www.denso-wave.com/>

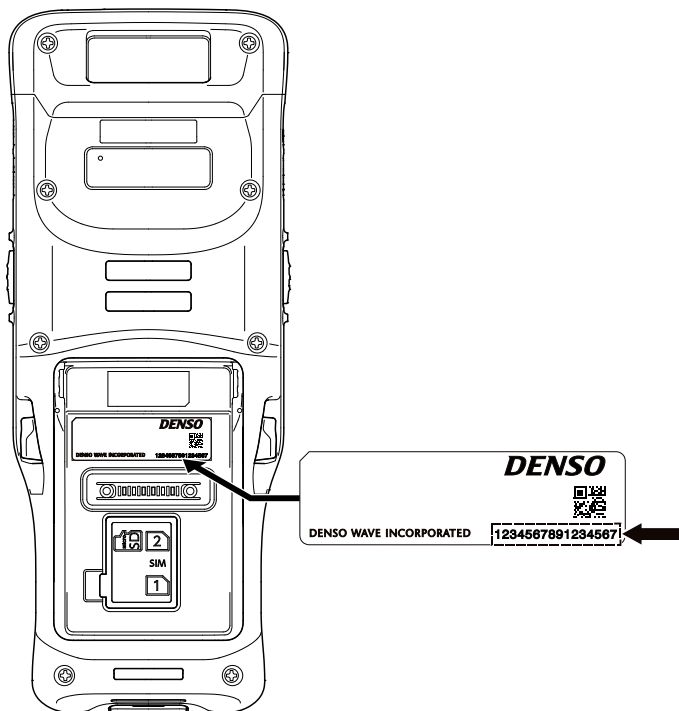

The serial number for registration is found under the QR Code on the name plate.



 **CAUTION**

Handling the BHT

Wrong handling of the BHT may affect normal operation or result in overheating, smoke generation, failure, and vision disturbance. Be sure to observe the following.

	<ul style="list-style-type: none">• When using the hand strap or neck strap, exercise due care to avoid getting them caught in other objects or entangled in rotating machinery. Failure to do so could result in accident or injury.
	<ul style="list-style-type: none">• Do not move your ear close to the speaker while the Buzzer is beeping. Doing so could lead to hearing difficulty.• Do not operate the BHT in environments where static electricity can build into significant charges. Doing so could result in malfunction or mechanical failure.• Avoid dropping the battery cartridge or letting it undergo any strong shock or impact. Doing so could result in malfunction or mechanical failure.• Do not use the BHT near a wireless transmitter such as a personal radio or ham radio. Doing so could result in malfunction or mechanical failure.• Do not touch BHT with oily hands or gloves containing oil such as machine oil and grease. Doing so may cause the deformation and discoloration of a device.• Do not attach a wet BHT or rechargeable battery cartridge to CU.• Do not use excessive force when inserting or removing the battery cartridge. Doing so could result in malfunction or mechanical failure.• Keep magnetic cards such as a cash card or a credit card away from the BHT. Failure to do so could cause loss of magnetic data.

About This Product

The BHT-M70 handy terminal, powered by Android™ 10, is light-weight, easy to use, providing powerful and handy tools for the purpose of delivering flexibility in customization.

Specifically designed to work as an industrial PDA, it provides rich options for data collection, voice and data communication, long-lasting working hours, and so on. Its large color transmissive display guarantees ease in reading in all lighting conditions. Integrated with Bluetooth® v5.1+EDR, 802.11a/b/g/n/ac technologies, this BHT also includes a GSM/GPRS/EDGE/WCDMA/UMTS/HSDPA/HSUPA/HSPA+/LTE module (WWAN model only) to gain greater speeds and optimal mobility. In particular, an integrated GPS receiver is made available for use with third-party location-based applications.

This manual serves to guide you through how to install, configure, and operate this BHT.

We recommend you to keep one copy of the manual at hand for quick reference or maintenance purposes.

To avoid any improper disposal or operation, please read the manual thoroughly before use.

Features of This Product

- Built tough to survive drop test and sealed against moisture/dust to industrial standard IP67*.
- Android™ 10 operating system with a powerful Qualcomm® SDM660 processor
- 64 GB eMMC flash memory to store OS and software programs
- 4 GB LPDDR3 SDRAM to store and run programs, as well as store program data
- USB Type-C connector. Complied with Qualcomm Quick Charge 3.0. Using the accessory AC adapter AD8 from the USB port, the battery can be charged up to approx. 50% in 1 hour (when the 1900 mAh battery is used).
- One expansion slot for microSDHC card up to 32 GB or microSDXC card up to 128 GB. Speed class of Class 4 is supported.
- 13 Megapixel auto focus camera on the back side. White LED lighting on the back side as an auxiliary light for the camera.
- Left and right side triggers for ambidextrous scanning
- For wireless communications, Bluetooth® v5.1 (BLE) and v2.1 + EDR, wireless LAN 802.11a/b/g/n/ac MU-MIMO, GSM/GPRS/EDGE/WCDMA/UMTS/HSDPA/HSUPA/HSPA+/LTE/VoLTE (WWAN model only), near field communication (NFC), etc.
- Telephone function is also supported with a microphone and a receiver.
- There are one slot for nanoSIM cards (WWAN model only).
- A 3.2" color transmissive display with 480 X 800 pixels to deliver excellent visibility in all lighting conditions
- Dragontrail® PRO touch screen. Electrostatic capacity type multi touch panel with glove touch and function to avoid wrong operation by water-droplet.
- Various sensors are installed. Acceleration sensor, gyro sensor, proximity sensor, ALS, geomagnetic sensor.
- For global positioning systems (GPS), A-GPS, GLONASS, QZSS, BeiDou, and Galileo are supported.
- Use a wireless charging battery pack and a wireless charging battery charger, sold separately, enables non-contact charging.
- The built-in scan engine setup tool "Reader Configuration" provides a keyboard wedge functionality that is ready to use right after unpacking.

BHT-M70 Series

- The optional products include communication units CU-M70U/M70L/M70UQ, 4-slot terminal charger CH-M70-4, USB cable, lithium-ion battery, etc.

* IP67 is not a guaranteed value, but a test value at the normal temperature.

1 Quick Start Guide

1.1 Component and Functions

Upper side

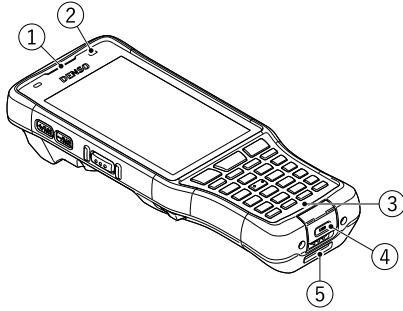

Lower side

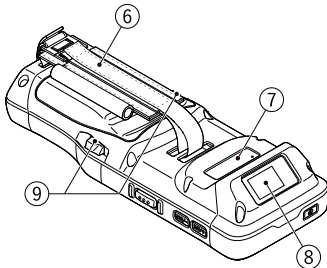

- ① Receiver, Speaker
- ② Status indicator
- ③ Microphone
- ④ USB connector
- ⑤ Interface connector
- ⑥ Hand belt
- ⑦ Rear camera
- ⑧ Code reading window
- ⑨ Battery cover locks

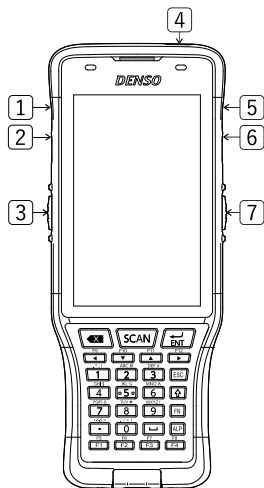

- ① M1 key
- ② M2 key
- ③ Left trigger key
- ④ Power key
- ⑤ M3 key
- ⑥ M4 key
- ⑦ Right trigger key

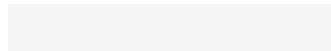
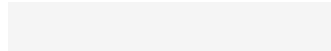

1.2 Supporting Model List

For the BHT-M70 Series, the equipped functions are different as shown in the table below.

	WWAN	GPS
BHT-M70-QW	—	—
BHT-M70-QWG	✓	✓

1.3 Mounting the Hand Belt

Attach the hand belt to each of the two places as shown in the figure.

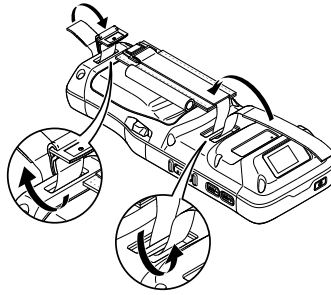

Connect the hand belt.

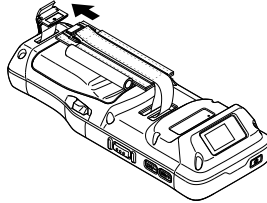

Install the stylus as shown. Select the right or left side of the hand belt.

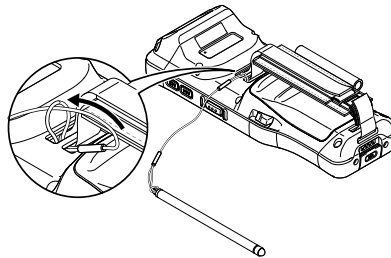

It is also possible to store the stylus in the hand belt.

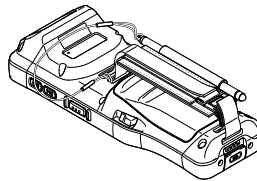

1.4 Installing and Removing Battery

The BHT main body and the battery are packaged separately due to the conditions of shipment and storage.

Caution: Incorrect handling may decrease the lifetime of battery.

Warning: Before powering on, confirm that the battery cover lock is positioned at the "Lock" position. To use BHT for the first time, install a charged battery and lock the battery cover. Then turn ON the power button.

Install and removing the battery in accordance with the following steps.

Step1

Inserting the battery

Insert the battery in the arrow direction.

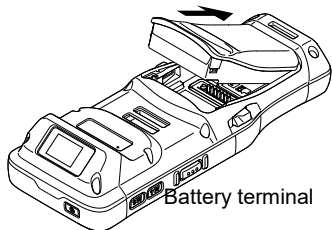

Step2

Push the battery in the arrow direction.

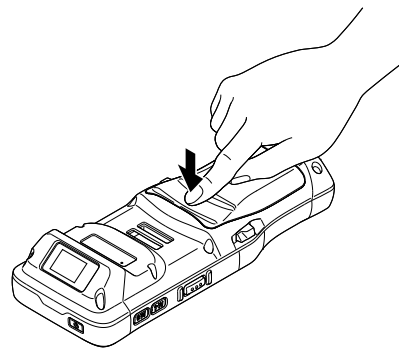

Step3

Removing the battery

Push the battery cover locks in the arrow direction.

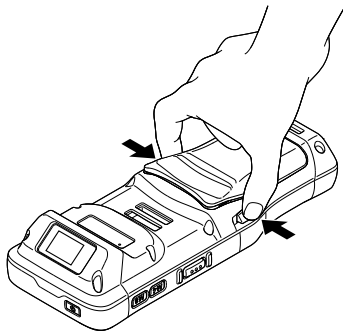

Step4

Pull out the battery with the battery tab held.

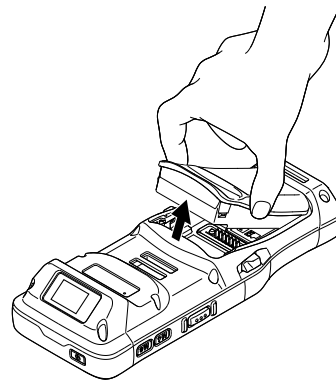

1.5 Installing and Removing SIM Card/microSD Card

BHT-M70-QW Handy Terminal Wireless LAN model is equipped with one microSD card slot.

BHT-M70-QWG Wireless LAN + WWAN model comes with one microSD card slot and one nano SIM card slot.

Installation of a card

1. Remove the battery by following the description of removing battery. Rotate the card cover in the arrow direction.

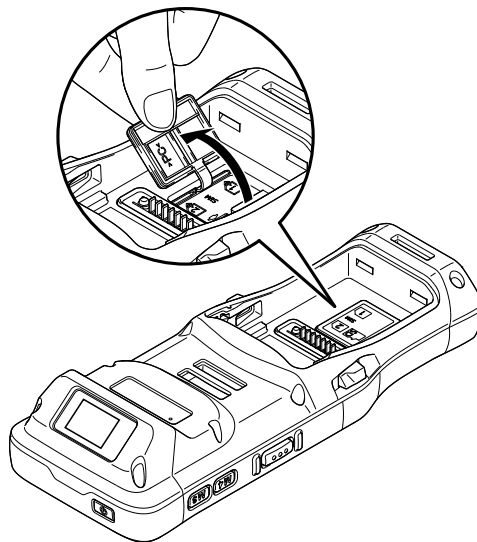

2. Insert each card into an appropriate slot in the arrow direction.

- (A) According to the arrow direction, insert the SIM card with contacts facing up, and the microSD card with contacts facing down. Do not touch the contacts of the card. Doing so may damage the card.

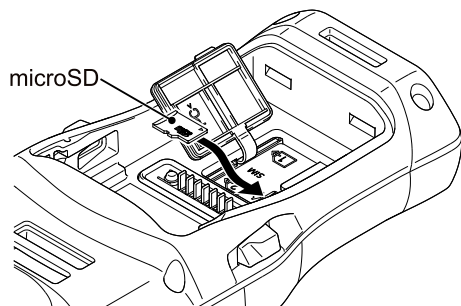

microSD card

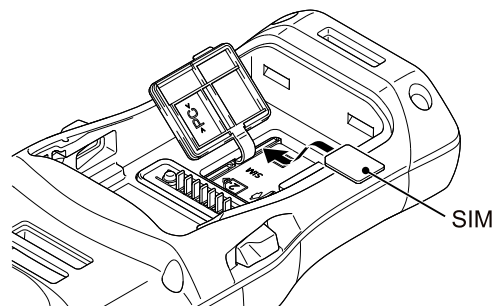

nano SIM card

- (B) Push in the card with a fingertip until it fits in the slot..

Never use an actual pen or other sharp object to insert the card. Otherwise, internal parts may be damaged and result in failure of the device. While the SIM card is locked with a click, the microSD card is not locked. Push the microSD card slowly until it reaches the indicated line.

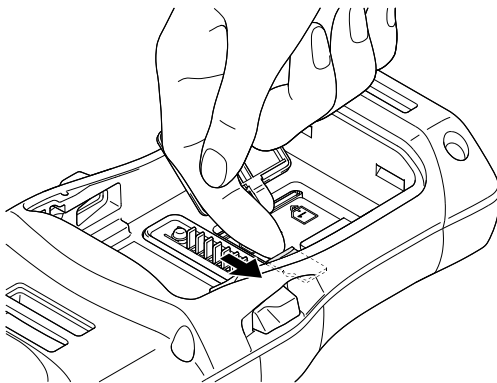

For the microSD card

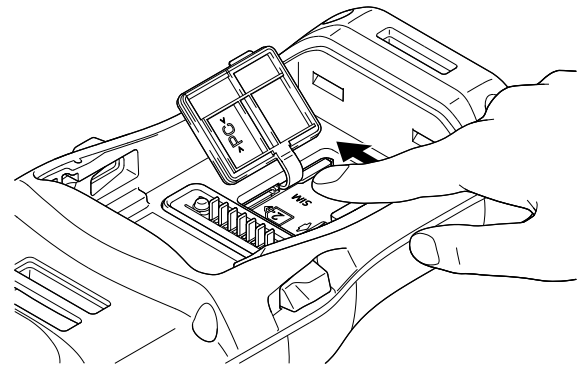

For the SIM card

3. Reinstall the card cover.

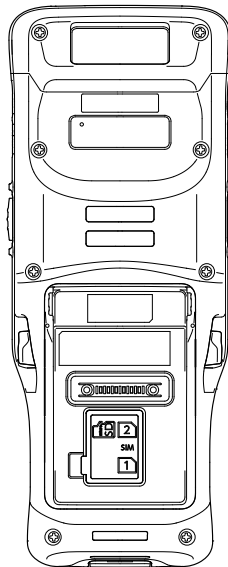

Supporting card

1. SIM1 card relevant functions are only supported on the WWAN model. For more details on specification-wise differences between the WWAN and WLAN model, refer to Specifications.

Removal of cards

1. Remove the battery.
2. Push a card with a case of the card slot pressed down with your fingers.
3. The card slot is unlocked and the card is ejected. Then, pull out the card with your fingers.

4. Place the battery cover back and push the battery cover lock to the "Lock" position.

Do not use a pointed object such as a pen tip when removing a card. Doing so may damage internal parts and result in inappropriate terminal operation.

1.6 Power ON/OFF BHT

Power ON

To power on BHT, press and hold the power button  located on the upper right side of BHT. BHT will turn on and show the lock screen after splash screen. Swipe the lock screen upward to display the home screen. BHT will not turn on unless a battery cover is fixed to the right position.

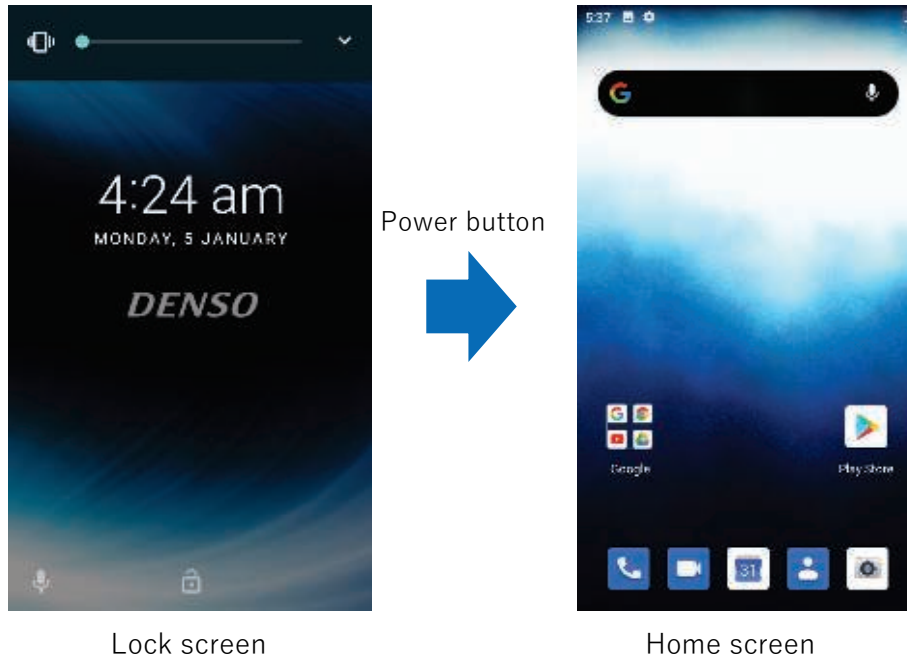

Note:

If the BHT does not start up by pressing the power key, or an unexpected screen appears, try the following solutions.

1. Suspend (Sleep) and resume the BHT by pressing the power key twice.
2. Turn off the BHT from the popup menu then press the power key for more than one second to turn on the BHT.
3. Reboot the BHT by pressing the power key for approximately 10 seconds.
4. Remove the battery then leave the BHT for approximately 30 minutes to discharge the sub-battery. Reattach the battery then press the power key for more than one second to turn on the BHT.

Power OFF

Press the power button , and a menu will appear on the screen which allows you to power off BHT. Make sure all user data have been stored before tapping on Power off.

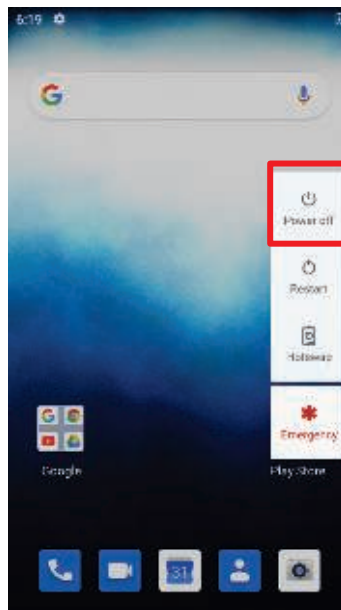

1.7 Charging

The battery may not be charged to full for shipment. When you first receive the kit package, you need to charge the battery to full before using BHT. You may use the Communication Unit or multiple BHT charger to charge the BHT.

1.7.1 Charging time

The battery powers the BHT to work. It takes approximately 3 hours to charge an empty battery to full. The status indicator above the screen (located on the right) will light up in red while charging and will turn Blue when charging is complete.

If the battery is completely discharged, it may take approximately 1 minute to start charging (to illuminate the status indicator).

When the battery is removed, BHT data will be retained for at least 5 minutes.

The sub battery is mounted on the main board. Its role is to retain data in DRAM when the battery is replaced. Replace the battery within 5 minutes. To charge a sub battery to full, it takes approximately 10 minutes from the completely discharged state to the fully charged state using the battery or power adapter.

1.7.2 Charging temperature

It is recommended to charge the battery at room temperature (18 °C to 25 °C) for optimal performance.

Note that battery charging stops when the ambient temperature drops below 0 °C or exceeds 40 °C. However, it may differ from the temperature under the actual usage environment.

1.7.3 Operation on battery power

When 802.11a/b/g/n/ac, GSM/GPRS/EDGE/WCDMA/UMTS/HSDPA/HSUPA/HSPA+/LTE, Bluetooth® v5.1&v2.1+EDR and GPS are all enabled on battery power, the battery level will drop down substantially. Prolonged use of the display and continued scanning of barcodes will also affect battery level.

In order to prevent system from shutting down after the battery is drained out, we suggest that you keep a fresh battery for replacement at all times, or connect BHT to the Communication Unit or USB Direct Cable for charging.

1.7.4 Use of USB Direct Cable

The USB Direct Cable provides a convenient way to charge your BHT.

Fasten the USB Direct Cable to the lower end of the BHT.

Connect the other end of the cable to the USB port or the USB power adapter of a host computer.

It may take long to charge to full depending on the power supply capacity of the host computer.

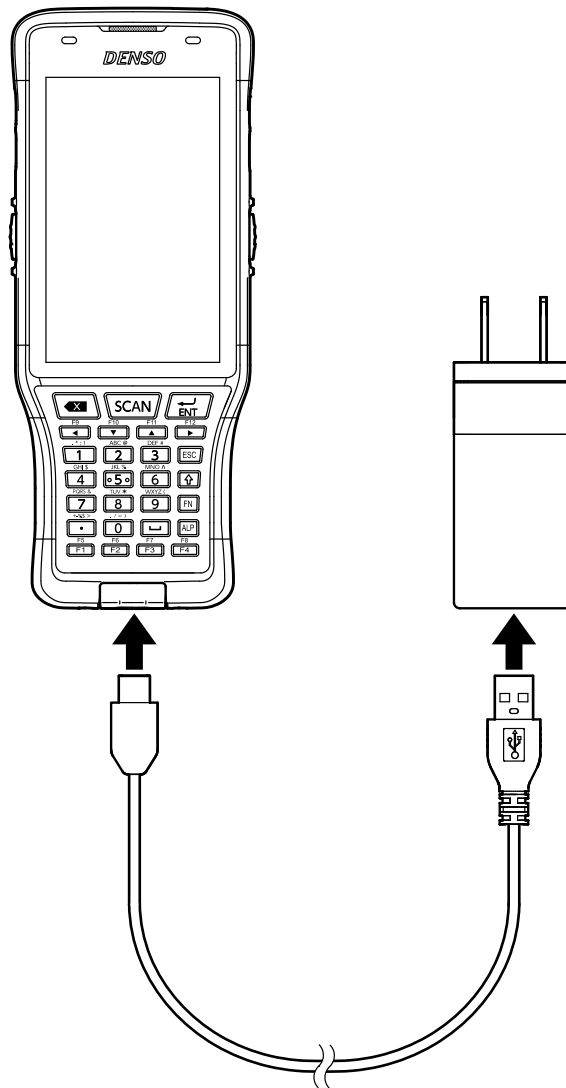

While the battery is being charged, the status indicator on BHT will indicate the charging status.

Status	Description
Red, solid	While charging BHT
Red, blink	Charging error (Charging will stop.)
Blue, solid	Charging complete
No light	Waiting

1.7.5 Use of Communication Unit

The Communication Unit charges both your BHT and a spare battery at the same time.

Preparation of Communication Unit

Connect the AC adaptor to the Communication Unit.

To carry out data communication, connect a communication cable to the Communication Unit.

Using the power adapter to connect the CU-M70U to the power supply.

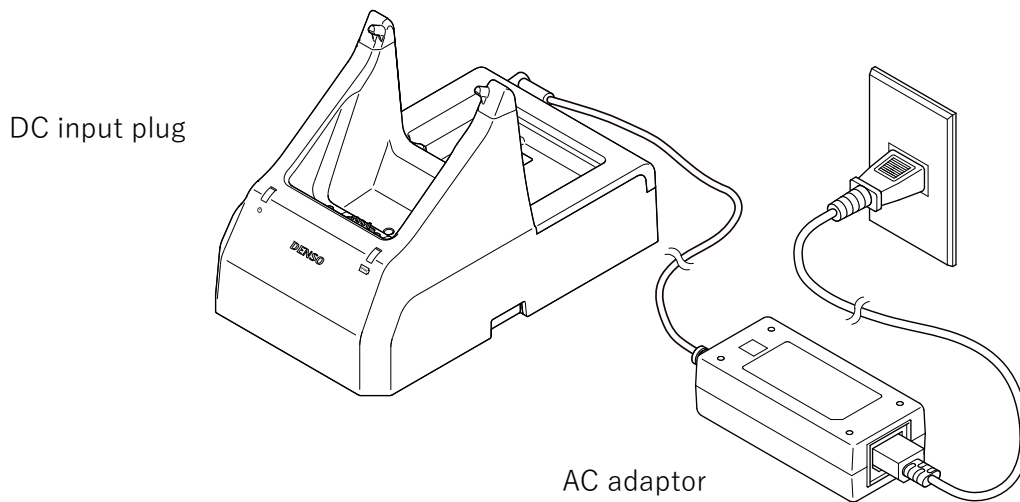

To power supply, the CU-M70U equipped with a USB interface can be connected with the power adapter and the USB cable. To charge both BHT and a spare battery use the power adapter.

Be aware that charging a deteriorated battery may result in an error and replace it with the new one.

Charging only with the USB cable provides charging for the BHT only.

Using the USB power adapter to connect the CU-M70UQ to the power supply.

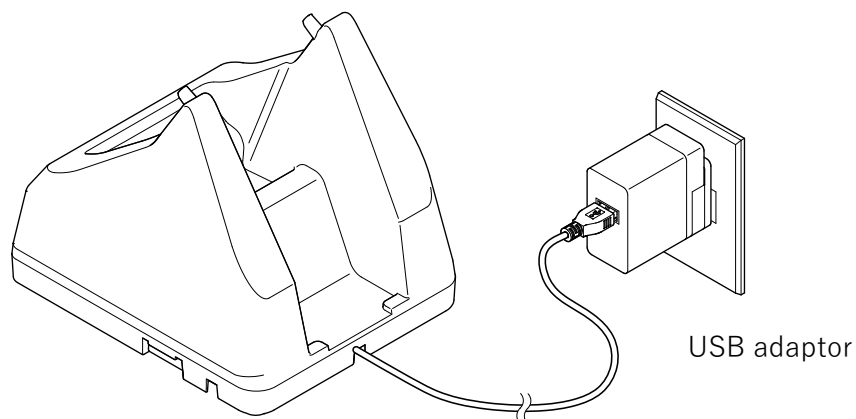

Charging procedure

Place the BHT upright and gradually tilt away from you.

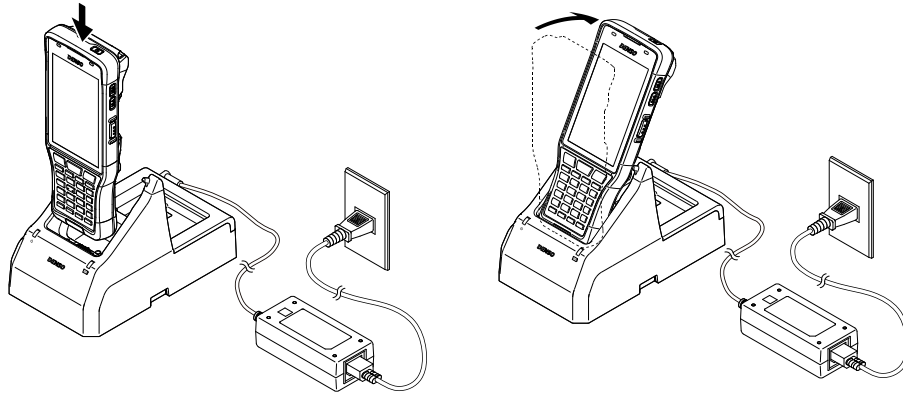

Note: When placing the BHT on the cradle, ensure there is no tangled strap between the device and the cradle. A specific part of the BHT may get warm while charging depending on operating environment and conditions. This is not a malfunction.

Removing the BHT from the Cradle

Tilt the BHT toward you and pull it out perpendicularly.

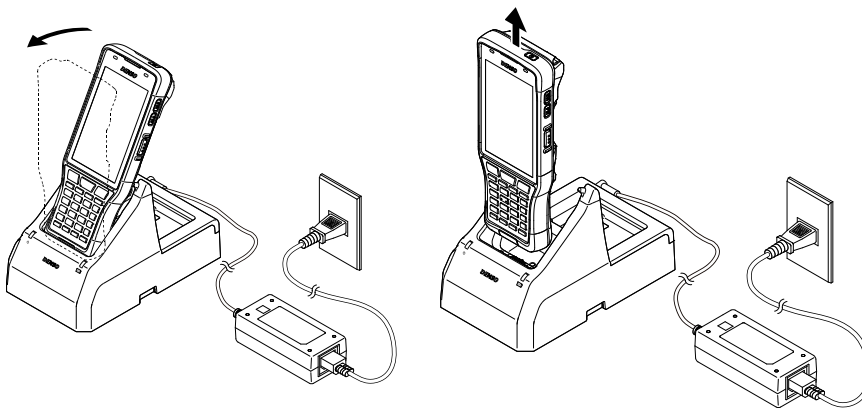

Notice on the power connection of the charging cradle

As for CU-M70U with the USB interface, both the power adapter and the USB cable can be used.

To charge both BHT and the spare battery, use the power adapter.

When charging with the USB cable, only BHT can be charged. Under the conditions, such as when the large capacity battery is installed in the BHT or when the BHT is under operation while charging, the use of the power adapter is recommended because these conditions may result in long-time charging or a charging error. Using a deteriorated battery may cause a charging error. In this case, replace the battery with the new one.

Charging Spare Batteries

CU-M70U spare battery charge indicator turns red and charging commences. The charge indicator turns blue upon completion of battery charging.

To install a spare battery, as the illustration below shown, incline and insert the spare battery into the battery well, and press it down to install properly.

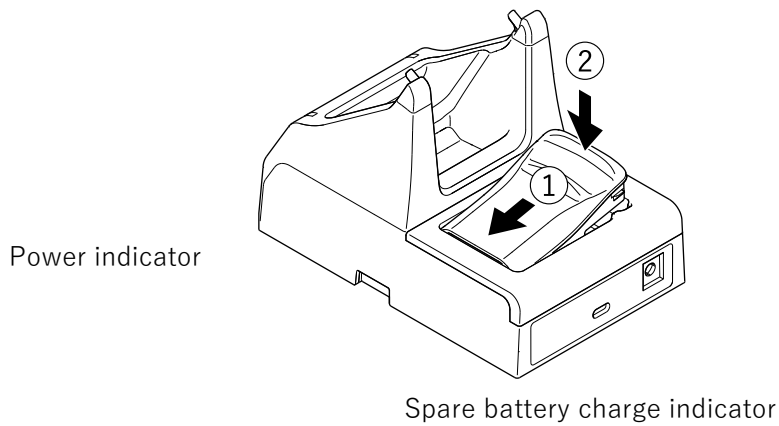

The status of BHT charging is shown on the status indicator of the BHT, while the status of spare battery charging is shown in the status indicator of the Cradle.

The battery charging status is shown as below:

Status	Description
Red, solid	While charging BHT
Red, blink	Charging error (Charging will stop.)
Blue, solid	Charging complete
No light	Waiting

Note:

The non-rechargeable event may be due to the battery being damaged, the battery not touching the connector, or the power plug being unplugged.

Charging errors may be due to overcharging time or too high battery temperature.

1.8 Communication

The barcode data collection system using BHT can connect various types of hardware to the BHT through each communication system.

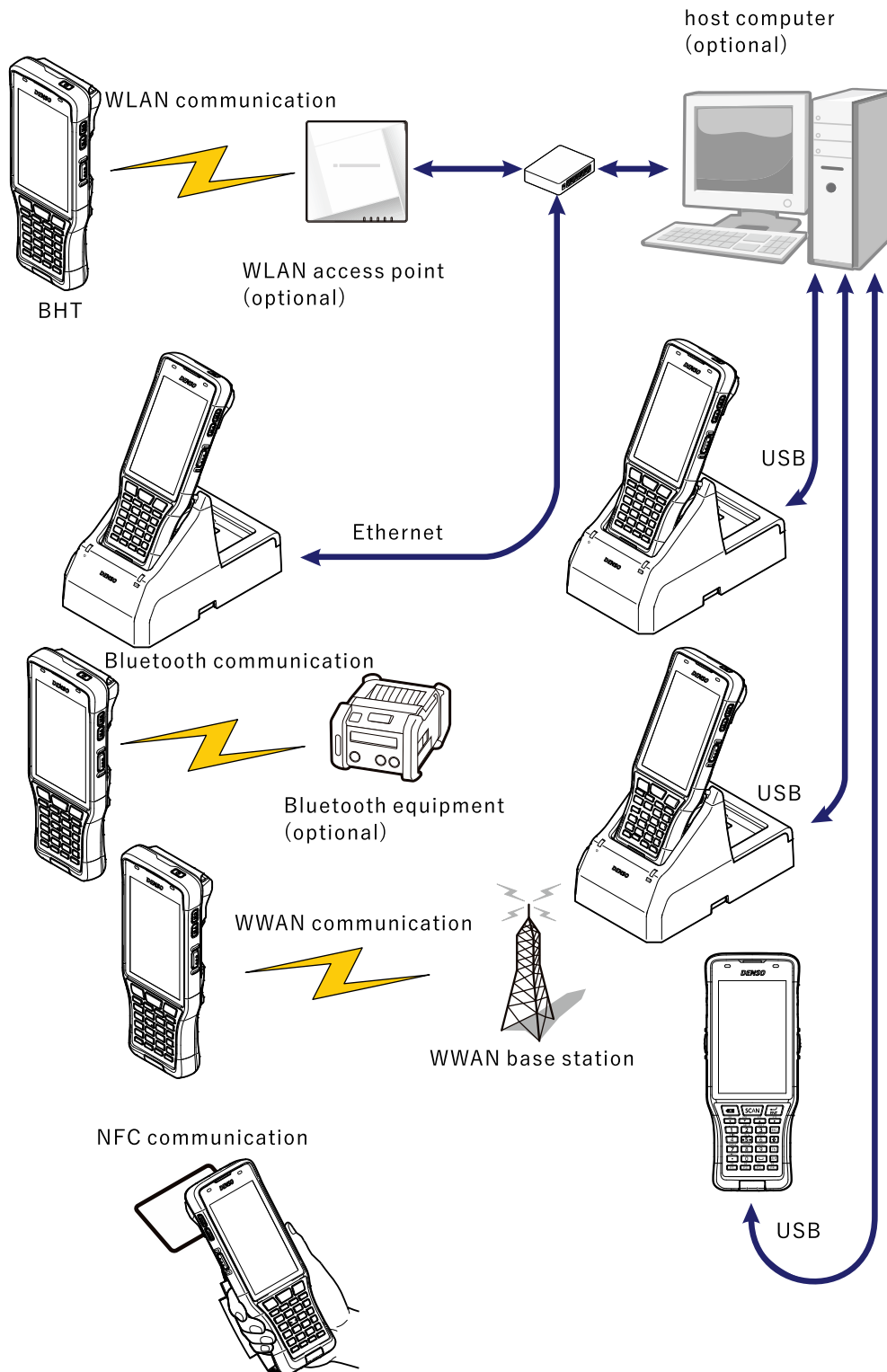

1.8.1 USB Communication

Communication between BHT and a host computer through the Communication Unit with USB interface or by directly connecting them using the USB direct cable to enable the data communication complying with USB2.0 standard.

For the connection with the Communication Unit, refer to BHT-M70 Software User's Manual.

For the connection using the USB direct cable, refer to BHT-M70 Software User's Manual.

For the data communication through USB, refer to "Data Communication by the USB Connection" in the BHT-M70 Software User's Manual.

1.8.2 Ethernet Communication

Communication between BHT and a host computer through the Communication Unit with the Ethernet (Wired LAN) interface to enable the data communication complying with 100BASE-TX or 10BASE-T standard.

For the connection with the Communication Unit, refer to BHT-M70 Software User's Manual.

For the data communication through the Ethernet, refer to "Wired LAN" in the BHT-M70 Software User's Manual.

1.8.3 WLAN Communication

Communication between BHT and a host computer through the LAN access point to enable the data communication complying with IEEE 802.11 a/b/g/n/ac standard.

For the connection with the Communication Unit, refer to BHT-M70 Software User's Manual.

For the data communication through WLAN, refer to "Wired LAN" in the BHT-M70 Software User's Manual.

1.8.4 WWAN Communication

Communication between BHT of WWAN supporting model and a host computer through the WWAN network to enable the data communication and the audio communication complying with GSM/GPRS/EDGE/

WCDMA/UMTS/HSDPA/ HSUPA/HSPA+/LTE standard. Available wireless interface depends on the telecommunications carrier providing WWAN.

For the data communication through WWAN, refer to "Mobile network" in the BHT-M70 Software User's Manual.

1.8.5 Bluetooth® Communication

Communication between BHT and a Bluetooth® integrating device to enable the data communication complying with Bluetooth® v5.1+EDR/LE standard.

For data communication through Bluetooth®, refer to "Bluetooth®" in the BHT-M70 Software User's Manual.

1.8.6 NFC Communication

NFC supporting model BHT can exchange NFC tags and data that satisfy Mifare and Felica specifications with NFC supporting devices.

NFC establishes wireless communication via electromagnetic fields in short distance (within 1 cm).

BHT can collect information from NFC tags and exchange information with other NFC supporting devices. Moreover, it can change the information of NFC tags if it has authority.

Perform the following operation before starting communication using NFC.

1. Swipe the screen upward, select Settings  in All apps, and tap Connected Devices  to open the connection settings.
2. Confirm that the NFC switch is turned ON.

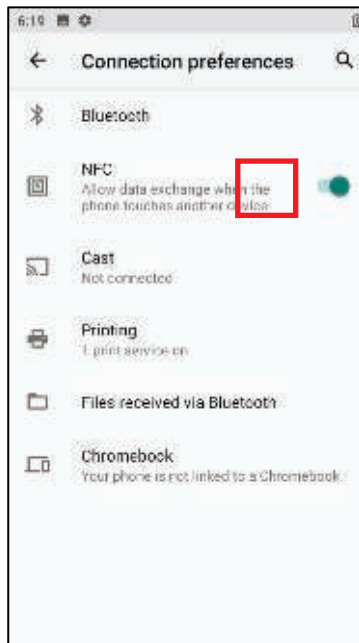

Communicating with NFC

1. Start up an NFC application on the BHT.
2. Hold BHT without covering the antenna at the reading window.
3. Place BHT near the NFC tag or the device until the application indicates that data transfer is completed.

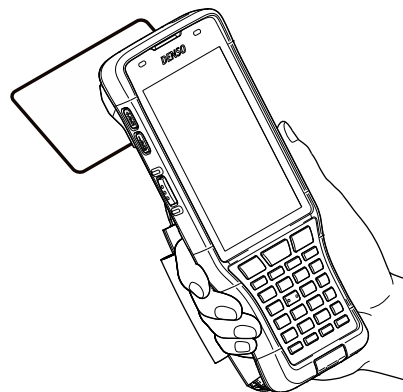

1.8.7 Airplane mode

Turning on the Airplane mode enables you to turn off all the wireless radios on your BHT (including call functions and data communication functions using Bluetooth®, Wi-Fi, and 3G/4G), which will considerably reduce power consumption of your battery.

3. To enter the Airplane mode, swipe down from the top of the screen with two fingers and open the Quick settings.
4. Tap on the Airplane mode icon, and you can switch turning ON/OFF of the mode.

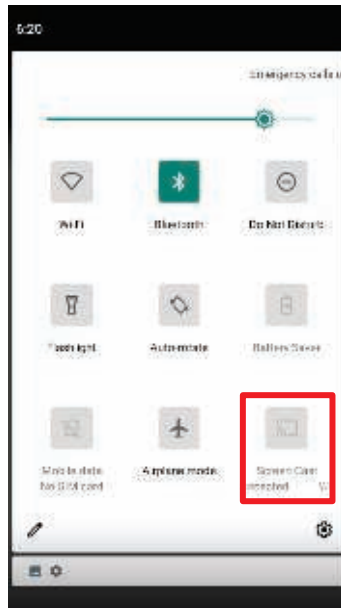

2 Using BHT-M70

2.1 Battery

Battery

BHT is powered by rechargeable Li-ion battery pack. It takes approximately 3 hours at 18 °C to 35 °C ambient temperature to charge them to full using the Communication Unit with AC adaptor or the charger. However, the charging time may vary by your working condition.

Sub Battery

Settled on the main board is a sub battery that is used to protect data of BHT when the battery is replaced. Replace the battery within 5 minutes. When the sub battery is charged by the battery or the power adapter, it takes approximately 10 minutes from the completely discharged state to the fully charged state.

Caution:

1. For a new battery, make sure it is fully charged before using.

2.1.1 Battery Status Indicators

The battery pack is the only power source for BHT to work. Therefore, when the battery level goes low, you need to replace the battery pack with a charged one or charge it as soon as possible. You should backup important data on a regular basis.

By checking the battery status icon on Status Bar, you can tell the battery level remaining in the battery.

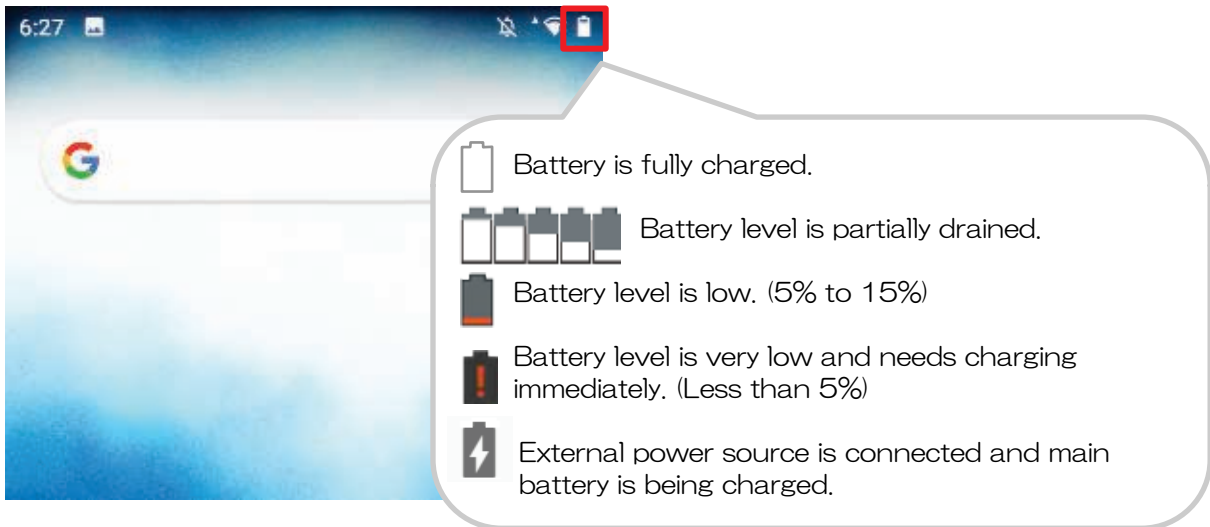

Note:

When BHT is fully charged and battery level reaches 100%, the battery icon will change from to to indicate that charging is completed.

Caution:

1. Once the battery level drops below 15%, the low battery notification will be displayed on the screen.
2. Data loss with RAM may occur when battery level is low. Always save data before the battery runs out of power or keep a fresh battery for replacement.
3. The level does not correctly display the actual remaining battery power of the rechargeable battery. Use it as a reference. The remaining battery level varies according to the operation of BHT, and there may be a difference between the actual battery voltage and displayed one. Charge the battery before the remaining battery level becomes low.

2.1.2 Monitoring Battery Level

Battery level

The battery is the only source that feeds BHT to work. It also supplies the sub battery on the main board in order to avoid the data loss. When the battery level gets low, recharge it or replace it as soon as possible. Most critically, back up the important data from time to time to protect your work.

To check battery level:

Tap All apps  | Settings  | Battery .

Battery level percentage is also shown to provide a clear grasp of the remaining battery power. The screen also shows the rate of battery discharge since the last battery charging session, how long the device has been running on battery power, and which applications are consuming the most battery power.

To look at the timeline of each application that drained or has been draining the battery power, tap on the chart, which enables you to diagnose any serious power drains.

To find applications that suddenly consumed the battery or are consuming, tap the menu at the upper right and tap Battery usage. You can diagnose power consumption in this screen.

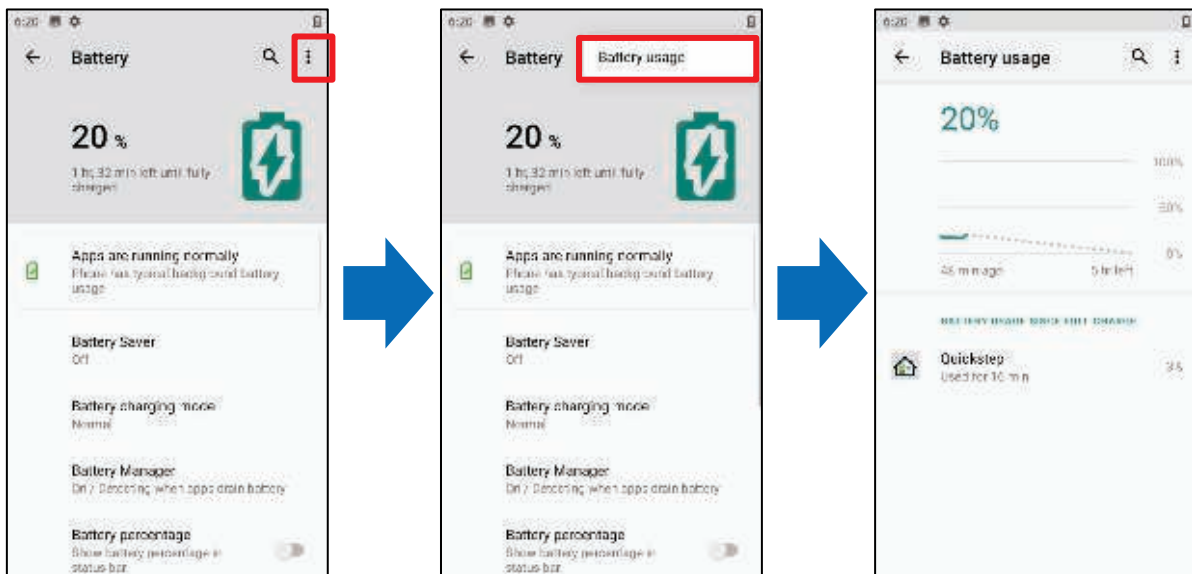

Battery saver mode

You can have the Battery saver mode automatically turned on when the battery level gets low. This mode will limit the use of location services, vibration and most background processing data.

1. To open Battery Saver, swipe down from the top of the screen and open Quickstep.
2. Tap Battery Saver to turn ON and OFF of modes.

On Battery screen, tap on Menu and then select "Battery saver".

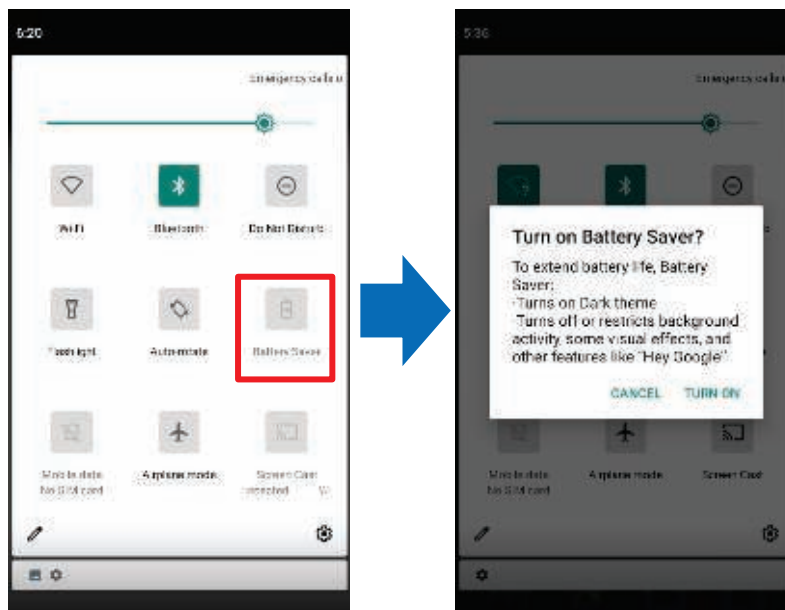

When Battery Saver is ON, the battery icon color in the title bar changes to orange. The screen also turns into the dark theme mode.



Turn ON this function and select the condition to automatically enable this mode.
When Based on percentage is selected, percentage can be specified.

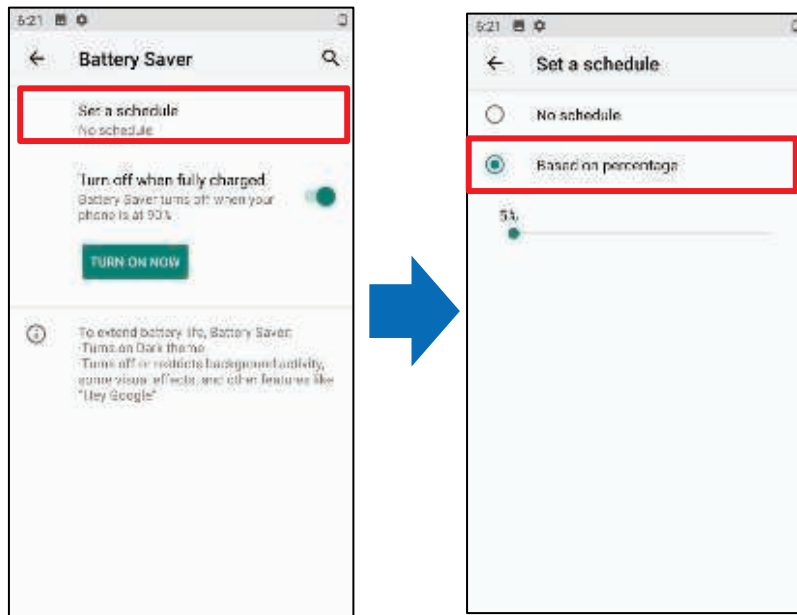



Battery optimization

With Battery optimization enabled for the applications, you can make sure they stay inactive when your BHT is idle or when applications have not been used for days.

On battery screen, tap Menu and then select "Battery optimization".

Make the setting by following the procedure given below.

Swipe the screen upward, select Settings  in All apps, tap Apps & notifications , and select "Battery optimization" from Special app access.

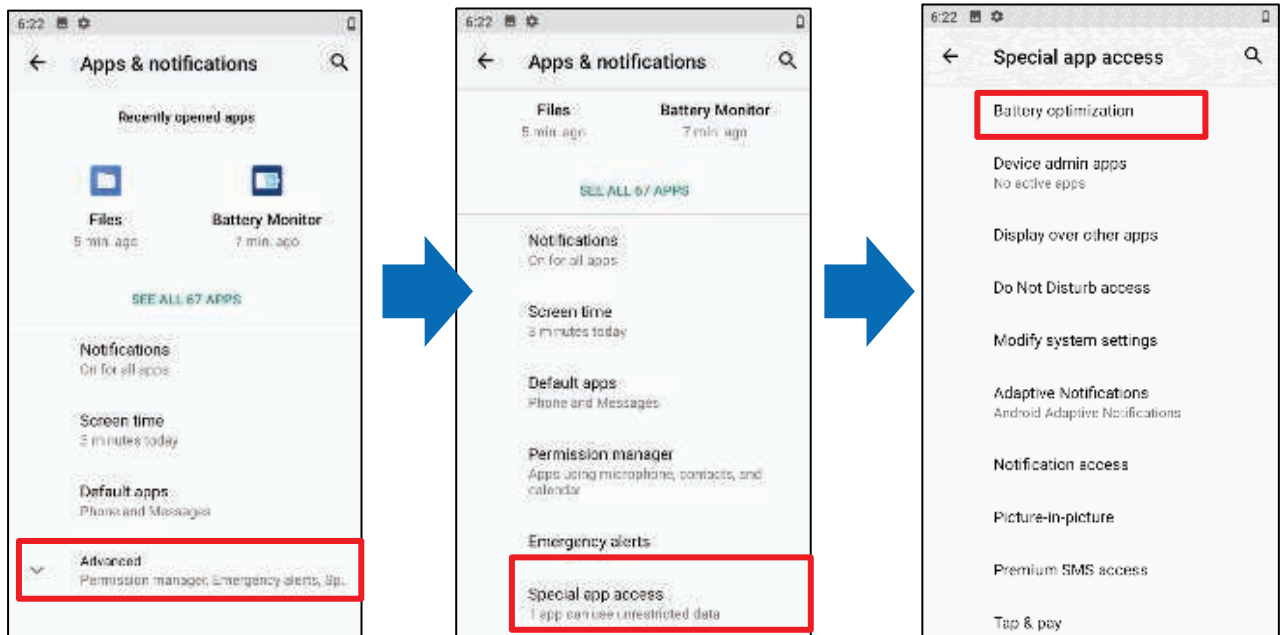

On the dropdown list, select "All apps", and all the applications will be optimized by this function by default. You can individually turn off the optimization mode of certain app. If you would like it always activated by tapping on the App. name, select "Don't optimize" and then "DONE".

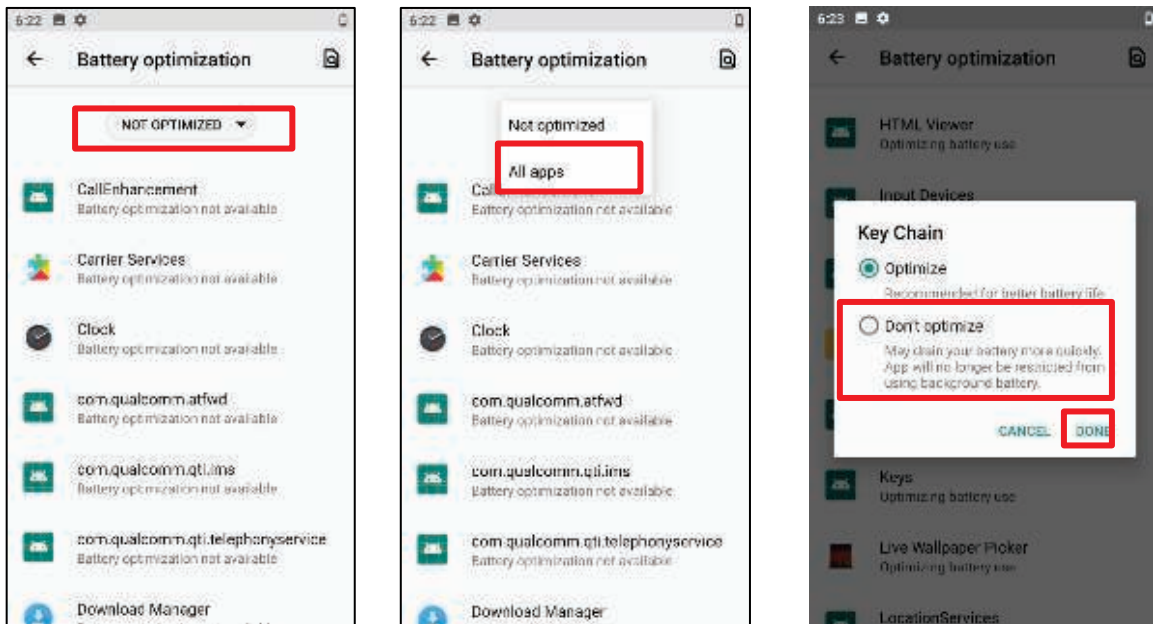

Low battery alert

BHT prompts a warning notification reminding you to charge the battery and the status indicator will blink red when the battery level drops to 15% and 5%.

Opening Notification Drawer, you will also see this warning appearing on the notification list; you may turn on Battery saver mode, connect BHT to an external power source, or replace the battery pack as soon as possible. To replace the battery pack, see Replacing battery.

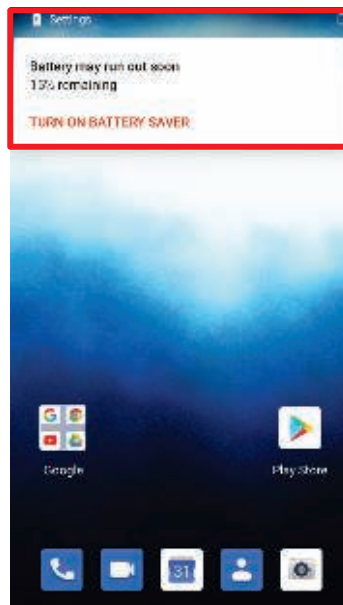

Replacing battery

When the battery level is low, follow the steps below to replace the battery.

1. Press and hold the power button on the side of the BHT.
Tap "Power off" in the pop up menu. BHT will power off.

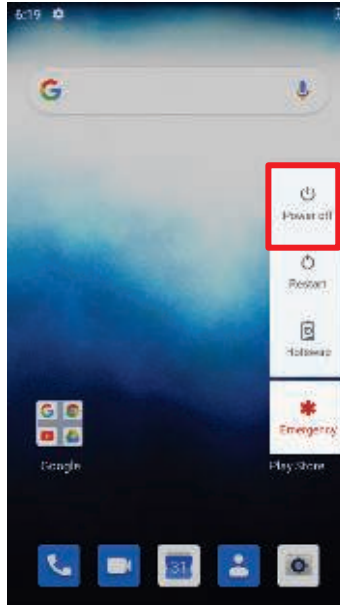

2. Open the battery cover and insert a charged battery as in Installing Battery.
3. Press the power button to power on.
4. Before replacing the battery, make sure the sub battery is well-charged in order to avoid unnecessary data loss. After removing the battery, insert a well-charged battery as soon as possible.

Hot swap

Sub battery supplies system power during battery swap.

When battery cover is removed, the system will enter suspend mode and not wake up until the battery cover is put back and the power button is pressed.

To perform the hot swap:

Make sure the new battery is fully-charged.

1. Long tap the Power button and select HOT SWAP. Press OK to go to hot swapping. The status indicator color changes to red. Wait until it turns OFF.
2. After the indicator is turned OFF, follow Step 1 to 2 in Installing Battery to remove the battery and replace it with a new one.

Note: When the battery is removed, the system will stay in the suspend mode. To avoid the system being shut down without any warning, please replace the battery within 5 minutes.

If the status indicator stays on after removing the battery, please put the battery back right away and perform the hot swap later.

2.1.3 Power Management

Here are some tips to help you save battery power.

Caution: Using backlight, wireless connectivity, and peripheral devices while on battery power will substantially reduce battery power.

- Bring an additional battery pack with you when you go out.
- End wireless connections (such as Bluetooth® transmission, wireless connection, NFC and GPS) which are not in use.
- If you do not need to use wireless connections, you can turn on the airplane mode to significantly reduce battery power consumption; see 1.9.7 Airplane mode.
- Reduce the screen brightness level. See the Software User's Manual 3.8.1. Brightness of Screen.
- Shorten the screen turn off time. See the Software User's Manual 3.8.3. Sleep Setting on the Display.
- Shut down automatic data syncing of applications (such as E-mail, calendar and contacts).
- Enable Battery saver mode and Battery optimisation mode. See Battery Saver Mode and Battery Optimisation Mode.

If you use the battery saver mode, the power will be automatically turned off while charging.

2.2 Memory

- 64 GB flash memory for storing the OS(Android™ 10) and custom application programs
- 4 GB RAM for storing and running programs, as well as storing program data
- Expansion slot

BHT is equipped with one SD card slot which can accommodate a micro SD card, a microSDHC or a microSDXC card. When selecting an SD card for the best compatibility and performance with BHT-M70 series, please make sure of the capacity you need. For the use of SDXC card, please use a new card and make sure that it has not been used in other host devices (computers, cameras, or SD card readers).

Card	Capacity
SDXC	64 GB – 128 GB
SDHC	4 GB – 32 GB
SD	128 MB – 2 GB

Caution of data loss

When the battery is removed or drained, the sub battery on the main board takes over to supply BHT and keep it in suspension. A fully charged sub battery will retain the data in the RAM for 5 minutes. When the sub battery is drained out as well, BHT will shut down, and all unsaved data will be lost. If you want to put away BHT for a couple of days, you should be aware that data loss occurs when the battery and sub battery discharges completely. Therefore, it is necessary to backup data and files before putting away BHT.

2.3 Touch Screen

Touch screen of the BHT comes with 3.2" transmissive LCD with 480 by 800 pixels resolution. The LED backlight of the screen, which helps ease reading under dim environments, can be controlled manually and automatically.

Note: Do not use any pointed or sharp objects to move against the surface of the screen.

If the touch screen is charged with static electricity, the device response may be inadequate.

Double pressing the Power button to Off to On screen is the solution of the static screen.

If it remains unchanged, long tap the Power button to reboot the device.

2.4 Notifications

2.4.1 Status Indicator

Status indicator located above the touch screen provide information about charging status, scanner light beam, and scanner "Good Read" during data collection.

Action	Status indication	Description
Charging	Blue, solid	Charging complete
	Red, solid	Charging BHT
	Red, blinking	Charging error (for instance, battery not in place)
Barcode decode	Blue, flash once	Good read
BHT is on sub battery power. (The battery cover is removed.)	Red, solid	Upon the removal of the battery cover, the red light is on for a while and then goes off to signal that the battery is ready to be removed. Please refer to Hot Swap to perform a successful battery swapping.

Note: To enable the notification of barcode decode, it must be turned on in the Reader Configuration.



2.4.2 Audio

The speaker is used to play sounds for events in windows and programs, or play audio files. In addition, it can be programmed for status feedback. BHT also supports using Bluetooth® headsets. If the optional USB Type-C to Audio conversion cable is used, a headset with a 3.5 mm audio jack can be also used.

Supported audio file formats include: WAV, MP3, AAC, AAC+, Enhanced AAC+, AU (including ADPCM), Midi, XMF, AMR (NB and WB).

Use the volume buttons on the side of BHT to adjust the system volume.

2.4.3 Vibration

BHT is integrated with a vibrator and it can be helpful when working in noisy environments. You may also set BHT to vibrate only, in which all system sounds will be muted and replaced by the vibrator. On any screen, press down Volume Up or Volume Down key to open the quick sound menu. Tap  to switch BHT to Vibration mode. To modify specific sound settings, tap  to access more settings.

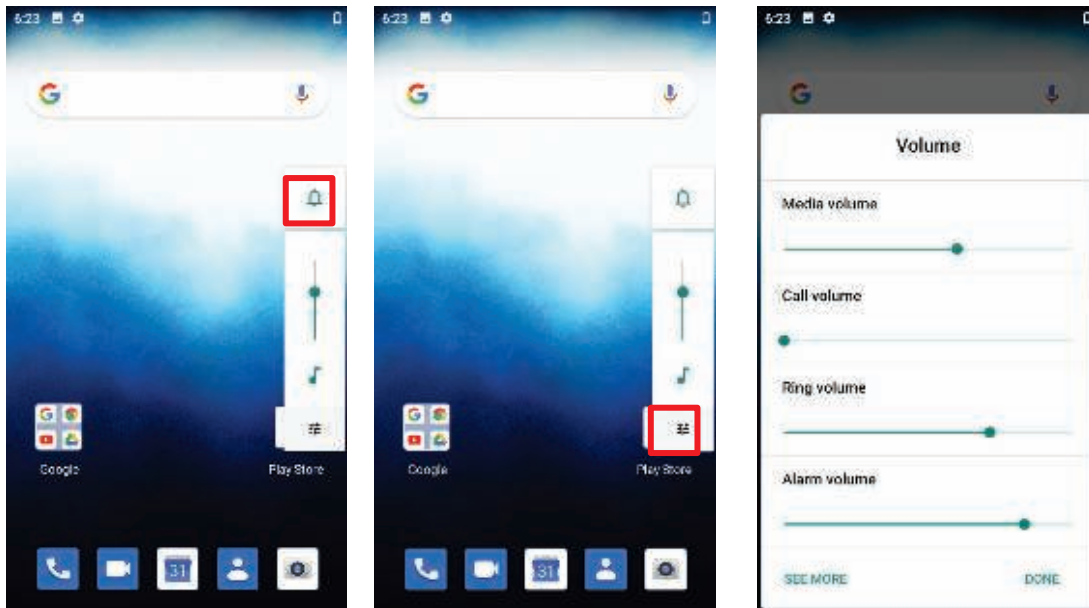

2.5 Cameras

An 13-megapixel rear camera integrated in BHT is specially designed for collecting image data. You may use the Camera application to take images. By default, the images taken by this camera application are saved as JPG files in DCIM folder in the BHT's main storage.

2.6 Legal Information

Confirm the legal information.

Swipe up from the bottom of the screen then tap "BHT Shell" from the app icons to start up the BHT Shell app. Tap "5. System Info" -> "2.Regulatory Info"

Legal information is displayed.

3 Basic Operation

This chapter describes the basic skills to work with BHT-M70 handy terminal, for instance how to operate the home screen, check of system statuses and management notifications.

The add-on utilities for applications regarding data reading, processing and transmission are introduced in the following chapters.

3.1 Reading Barcodes

Read barcodes as described below.

1. Press the power button to power on BHT.
2. Start up the code reading application.
3. Point the reading windows towards the barcode to read and press one of the side triggers.

Light for reading is irradiated and the printed barcode is read.

The light for reading goes off when the data are decoded or the decode time has elapsed.

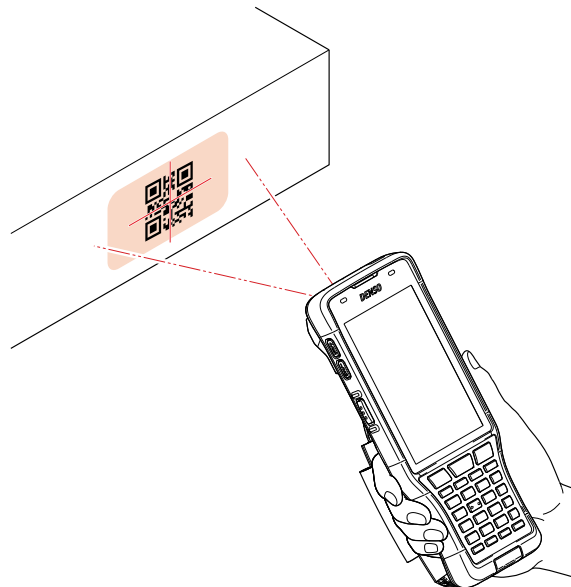

3.2 Keyboard Input

When the text input field appears, the on-screen keyboard is opened automatically. The style of keyboard varies according to the data type (texts or numbers) this field requires. Data can also be input with the keyboard in the main body of BHT.

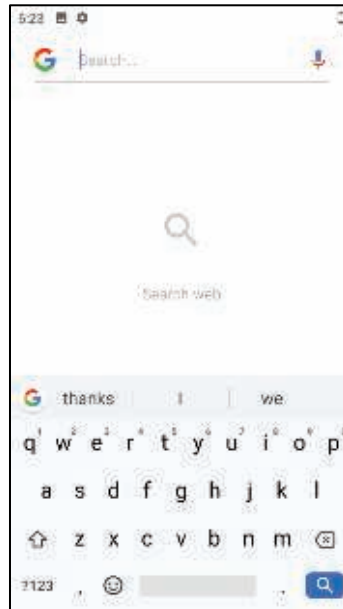

3.3 Data Transmission

Data collected by BHT can be transmitted to the host computer by USB communication, Ethernet communication, Bluetooth® communication, WLAN communication and WWAN communication. Data transmission methods and setting methods vary according to the system our customer uses. Please contact a system administrator for details of the operation. Upload collected data to the host computer as soon as possible.

3.3.1 Suspend mode

To minimize power consumption and prevent unintended operation, suspend BHT if you are not actively using it. BHT can be quickly awoken from suspend mode to operate as needed. When BHT enters suspend mode, the system is in a power-saving status, meaning that the BHT will not respond to screen touch, and that volume keys and side buttons will also be unavailable until the BHT is unlocked.

Suspending BHT

Press the power button  to suspend BHT. BHT will automatically suspend when the period set in the Screen Timeout Settings has passed without any activity.

3.3.2 Security lock

Setting a screen lock allows you to protect your personal data on the BHT while it is not at your hand. Since various types of screen lock and Smart Lock are available, you cannot only enjoy the benefits of this function but also great convenience.

Locking BHT

Tap All apps  | Setting  | Security  | Screen Lock to change the lock method.

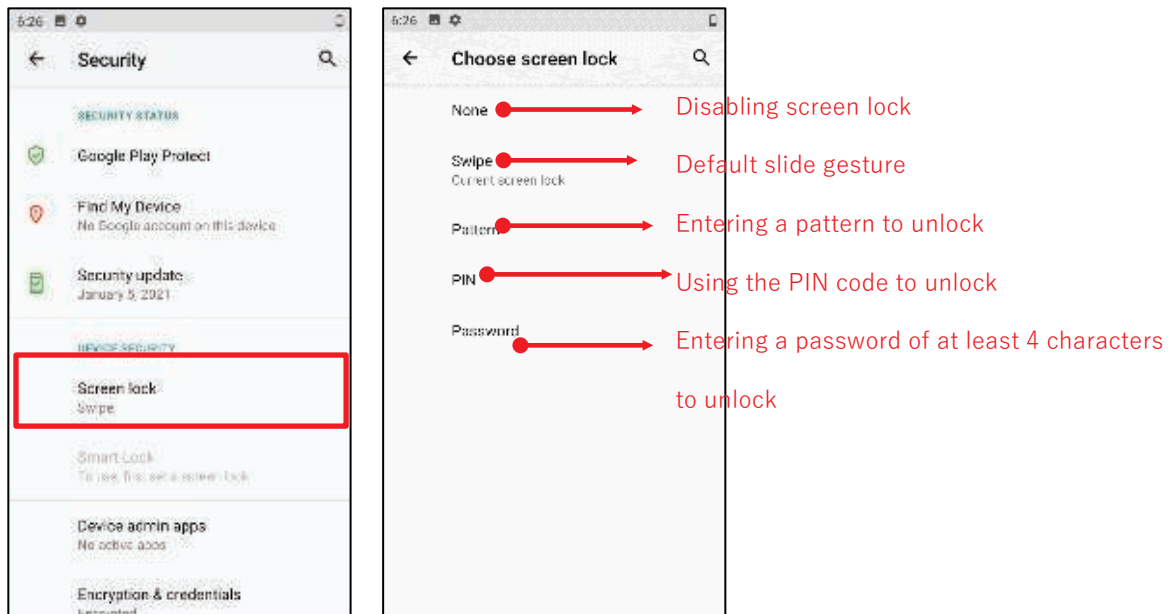

By selecting a method, such as pattern, PIN or Password, you can access advanced settings to customize personal lock settings.

To save battery power, suspend BHT when not in use.

3.4 Resetting to the Factory Default

Resetting to a factory default will erase all data on your BHT including call logs, messages files as well as your installed apps and their associated data, and revert the BHT back to its original state in which you powered on for the first time. It is strongly recommended that you back up important data before resetting to the factory default.

Reset to the factory default as described below.

1. Swipe the screen upward, tap All apps, Settings , System , Advanced, and Erase all data (resetting to factory default).

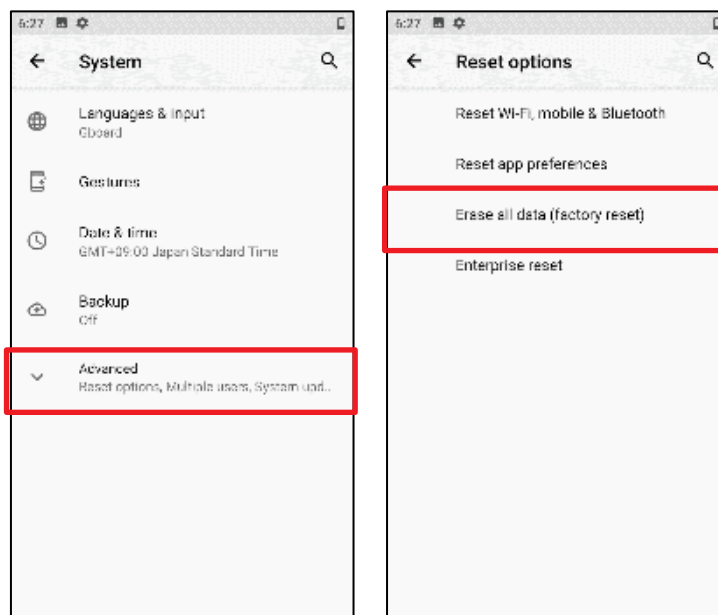

2. Tap RESET PHONE and then tap ERASE EVERYTHING to reset to the factory default.



4 Maintenance

4.1 Storing the BHT

Store the BHT with a fully charged battery installed.

4.2 Handling the Batteries

4.2.1 Battery Life

Batteries are consumables. As the charging is repeated, the battery service life per charge declines. If a battery as described below is used, replace the current battery with a new one: When the recharge has been repeated to a battery more than 300 times, or when a battery has been used for more than one year.

4.2.2 Battery Swell

The battery may swell depending on the condition as the expiry of its service life approaches. This is a nature characteristic of a lithium-ion battery and is not safety hazard. As the expiry of battery approaches, its service life declines and it may also be difficult to install or remove a battery in/from the body of the terminal due to the swell of the battery. Replacing the battery sooner is recommended.

4.3 Handling the SIM Card / microSD Card

This product incorporates connectors for SIM cards and microSD card. Do not insert anything other than these cards. Do not insert a card inversely, diagonally and with twisted. Do not insert a card with a pointed object such as a pen tip or a flat-blade screwdriver. If a card is inserted forcibly, this could damage a card or a connector.

For procedures to install or remove a card, refer to 1.5 Installing and Removing SIM Card/microSD Card.

4.4 Daily Maintenance

4.4.1 Proper Care of the BHT

Wipe any dirt from the BHT housing, interface connector terminals, and battery terminals with a dry, soft cloth.

Make sure to turn OFF the BHT before cleaning.

Notes

- Never use substances such as alcohol, as this may cause the housing to be marred or paint to be peeled off.
- Never rub or strike the LCD with anything hard, as this may result in scratches on the screen or breakage.

If excessively dirty, wipe with a soft cloth that has been soaked in soapy water (always use a neutral detergent) and wrung out thoroughly.

Any dirt or dust adhering to the barcode reading window (clear plate) will degrade reading performance.

Check regularly whether any dust has accumulated on the reading window (clear plate), if using in dusty areas.

Follow the steps below to clean the reading window:

First, blow the dust away with an airduster, and then gently wipe the plate with a cotton swab or similar soft object. If sand or hard particles have accumulated, rubbing the window may result in scratches. Then, blow any particles away with an airduster or wipe with a soft brush.



4.4.2 Proper Care of the CU

Unplug the AC adapter from the socket when cleaning the CU for safety.

Wipe any dirt from the housing or charge terminals with a dry, soft cloth.

Important Notice of Disinfection and Maintenance for DENSO WAVE AUTO-ID Products.

As described in the care and maintenance of the Operator's Guide* contained in the package of regular AUTO-ID products, the usage of thinner and alcohol for cleaning is prohibited.

In consideration of the currently widespread novel coronavirus infection, DENSO WAVE performed the wiping test under its own test standards using 70% ethanol or 10 ppm to 80 ppm hypochlorous acid water in expectation of a certain disinfection effect. As a result, we visually confirmed that there is no remarkable discoloration and color fading on the surface of the housing. Before using the solutions described below, please read and understand the following descriptions.

Test description: Wiping the outer surface of a product excluding the reading window, the dust-proof plate and cables with the robot arm 1,500 times

Solutions: 70% ethanol/ 10 ppm to 80 ppm hypochlorous acid water/ 70% isopropyl alcohol/ 3% hydrogen peroxide

Applicable models: AUTO-ID product models selected by material and posted on the DENSO WAVE's website.

Note

- Do not apply any liquid on the reading window or the dust-proof plate. Never get any liquid into narrow spaces such as holes and slits.
- When wiping, be sure to use a soft cloth. If any liquid remains after operation, wipe it off with a dry and soft cloth.
- This description does not guarantee the product specifications. Product degradation such as housing degradation may become apparent depending on the operation environment.

5 Specifications

5.1 Model/Platform/Processor/Memory

BHT-M70 comes in t models as described below:

WWAN model: BHT-M70-QWG

WLAN model: BHT-M70-QW

5.1.1 Operating system/CPU

OS version	Android™ 10
CPU	Qualcomm® SDM660
Memory	
ROM	64 GB eMMC
RAM	4 GB LPDDR3 SDRAM
Expansion Slot	microSDHC/SDHC/SDXC card slot X 1 nano SIM socket X 2

5.2 Communication/Data Capture

5.2.1 Communication

Bluetooth®	Bluetooth® v5.1(BLE)/ Bluetooth® v2.1+EDR
WLAN	IEEE 802.11a/b/g/n/ac,MU-MIMO2x2
WWAN (Not supported on WLAN model)	GSM/W-CDMA/LTE/VoLTE [Radio frequency] FDD-LTE (4G) - Bands 1, 3, 5, 8, 19, 26, 28 W-CDMA/UMTS/HSPA/HSPA+ (3G) - Bands 1, 6, 8, 19
GPS (Not supported on WLAN model)	A-GPS/GLONASS/QZSS/BeiDou/Galileo.

5.2.2 Data/Image Capture

Cameras	Rear Camera 13-Mega pixels.
Code Reader	2D Imager
HF RFID Reader	ISO14443A/B (Mifare), ISO15693 (Felica) Supports NFC (P2P, Card reader, Card emulation) Perform a sufficient reading test with a card to be used preliminarily.

5.3 Electrical Characteristics

5.3.1 Batteries

Battery	Rechargeable Li-ion battery: 3.6 V, 3050 mAh BT3 Charging temperature: 0 ° to 40 °C Minimum charging time 3050mAh: 3 hours at 25 °C Please charge batteries from 0 ° to 35 °C in temperature. To ensure that the battery is being charged under a safe condition, battery disable charging when ambient temperature drops below 0 °C or exceeds 40 °C, and resume charging after its temperature returns within the acceptable range.
Sub Battery	Data retention for 5 minutes Charging time: 10 minutes

5.3.2 Working Time

3050mAh BT3	Approximately 20 hours.
-------------	-------------------------

Note

- Operation time is a reference value under normal temperature and varies according to the use conditions.
- It is measured based on JEITA HT standard operating mode G and varies according to the operating environment and system settings.

5.4 Physical Characteristics

5.4.1 Color Touch Screen Display

Display	4.0" Transmissive IPS LCD, Dragontrail®PRO Glass
Resolution	HD (480 X 800 pixels)

5.4.2 Notifications

Status indicator	Lighting red when charging, Blue when charging is completed Lighting blue when reading is completed
Audio	Integrated with one speaker with echo and noise cancellation.

5.4.3 Dimensions and Mass

Dimensions (Length X Width X Height)	182 mm × 73 mm × 31 mm The height of the reading window is 40mm.
Mass (Including battery cover and battery)	Approx. 330 g with 3050mAh battery.

5.5 Environmental Characteristics

5.5.1 Temperature/Humidity

Operating	-20 ° to 50 °C, 5% to 95% RH (Non-condensing)
Storage	-20 ° to 60 °C, 5% to 95% RH (Non-condensing)
Charging	0 ° to 40 °C, 10% to 90% RH (Non-condensing)

Appendix I

Reading configuration

Symbologies supported

Codabar	
Code 11	
Code 39	Code 39 Trioptic Code 39 Italian Pharmacode (Code 32)
Code 93	
Code 128	Code 128 GS1-128 (EAN-128) ISBT 128
Code 2 of 5	Chinese 25 Industrial 25 (Discrete 25) Interleaved 25 Convert Interleaved 25 to EAN-13 Matrix 25
Composite Code	Composite CC-A/B Composite CC-C Composite TLC 39
GS1 DataBar (RSS)	GS1 DataBar-14 (RSS-14) GS1 DataBar Limited (RSS Limited) GS1 DataBar Expanded (RSS Expanded) Convert to UPC/EAN
MSI	
Postal Codes	Australian Postal Japan Postal Netherlands KIX Code US Postnet US Planet UK Postal

EAN/UPC	EAN-8
	EAN-8 Extend
	EAN-13
	Bookland EAN (ISBN)
	ISSN EAN
	UPC-A
	UPC-E
	Convert to UPC-A
	UPC-E1
	Convert to UPC-A
2D Symbologies	Aztec
	Data Matrix
	Maxicode
	MacroPDF
	MicroPDF417
	MicroQR
	PDF417
QR Code	

Handy Terminal

BHT-M70 series

Hardware

User's Manual

First Edition May. 2022

DENSO WAVE INCORPORATED